



BIM and ISO 19650 from a project management perspective

Organization and digitization of information
about buildings and civil engineering works,
including building information modelling (BIM)

Table of Contents

Abbreviations	4
Preface	5
1. Introduction	7
1.1. ISO 19650 and BIM	9
1.2. Aims of publication	10
2. ISO 19650 Standard	11
2.1. Introduction	11
2.2. ISO 19650 'Part 1: concepts and principles'	12
2.2.1. ISO 19650 in the life cycle	12
2.2.2. Definitions used in project management	13
(a) Building Information Modelling	13
(b) BIM Execution Plan	13
(c) Level of information need	13
(d) Information container	15
2.2.3. Two key concepts for consulting engineers	15
(a) Common Data Environment	15
(b) Requirements management	16
2.3. ISO 19650 Part 2: 'Delivery phase of the assets'	17
3. Important issues for managing BIM (but not covered by ISO standards)	23
3.1. Project management and BIM	23
3.2. Processes	23
3.3. Common Data Environment	25
3.4. Exchanging/sharing information in a BIM process	26
3.5. Effective BIM implementation from a project manager perspective	27
3.6. BIM deliverables – reusability	28
3.7. Education and training	31

4. BIM Execution Plan	32
4.1. Contents	32
4.2. Level of information need	34
(a) The level of development issued by BIM Forum, and currently used in a number of projects across the world;	34
(b) The level of detail issued by CityGML and used in the GIS domain	34
(a) Level of geometry	34
(b) Level of information	34
(c) Level of documentation	34
4.3. BEP and information management	36
4.4. BIM uses	37
5. Contracts	39
5.1. Intellectual ownership	40
5.2. Software tools	40
5.3. Liability	41
5.4. FIDIC impact	42
Appendices	43
Appendix 1: National video references and links	43
(a) What is BIM?	43
(b) Asset information management using BIM with open standards and a digital twin	43
(c) OpenBIM and buildingSMART	43
(d) Systems engineering and BIM	43
Appendix 2: Exchange and sharing (container-) information	44
Appendix 3: References to BIM guidance in Europe	46
Appendix 4: Table of project and task information management functions	47

Abbreviations

AIR	Asset information requirements	IDM	Information Delivery Manual
AIA	American Institute of Architects	IFC	Industrial Foundation Classes
AEC	Architecture, Engineering and Construction industry	IOT	Internet of Things
BCF	BIM Collaboration Format	ISO	International Standardization Organization
BEP	BIM Execution Plan	LEED	Leadership in Energy and Environmental Design
BIM	Building Information Modelling	OGC	Open Geospatial Consortium
BS	British Standards	OIR	Organisational information requirements
CDE	Common Data Environment	OTL	Object Type Library
CIC	Construction Industry Council	PAS	Publicly Available Specification
COINS	Constructive objects and the integration of processes and systems	PEP	Project Execution Plan
EUROTL	European Road Object Type Library	PIR	Project Information Requirements
FIDIC	International Federation of Consulting Engineers (Fédération Internationale Des Ingénieurs-Conseils)	RIBA	Royal Institute of British Architects
GML	Geography Markup Language (ISO19136)	QTO	Quantity Take-off
		SDK	Software Development Kit
		SE	Systems Engineering

Preface



Kevin Rudden
President EFCA

International standard ISO 19650, ‘Organization and digitization of information about buildings and civil engineering works, including building information modelling (BIM) – Information management using building information modelling’, has been published. It has two Parts – Part 1: Concepts and principles and Part 2: Delivery phase of the assets. EFCA, as liaison organisation in the European Committee for Standardization (CEN) TC 442¹, contributed to its development, helping to orient it for use in a BIM construction project – from the very beginning through to final delivery.

The title of the standard refers to “information management using building information modelling” (BIM). Today, in Europe, most of the biggest projects are designed under a BIM process. Being able to define a standardised process for information delivery means that it’s no longer a time to convince others of why BIM has to be used, but rather of how, in order to make BIM profitable for all stakeholders of a project in terms of quality and in terms of revenue.

Engineers and consultants must be central to information management. We can consider the art of the engineer as being included in ‘information management’ in order to communicate its added value to the construction works being delivered. This booklet can be regarded as the voice of engineers, explaining the use of ISO 19650 to other partners in the construction process.

The booklet has been developed in a collaborative way by the EFCA BIM Task Force, which includes representatives of European associations of consulting engineers and takes into account specificities of each country. It is oriented for the benefit of all, including small and medium-sized enterprises. The appropriate implementation of ISO 19650 opens the road for engineers to the revolution of the construction industry 4.0.

We hope this effort will be useful for all engineers and consultants, but also our partners in the construction industry.

¹ The technical committee for life-cycle information for the built environment.



ACKNOWLEDGMENTS

The publication was produced by the members of the EFCA BIM Task Force:

- Christophe Castaing, Chair (CINOV-SYNTEC, France)
- Daan Alsem (Koninklijke NLI ingenieurs, the Netherlands)
- Ingrid Alvsåker (RIF, Norway)
- Michel Bernard (CINOV-SYNTEC, France)
- Stig Brinck (FRI, Denmark)
- Ondřej Budík (CACE, Czech Republic)
- Boban Djordjević (ACES, Serbia)
- Szymon Dorna (SIDiR, Poland)
- Maximilian Grauvogl (VBI, Germany)
- Joseph Ickmans (ORI, Belgium)
- Veljko Janjić (ACES, Serbia)
- Ioannis Ladopoulos (HELLASCO, Greece)
- Gilles Pignon (OAI, Luxembourg)
- Fabrizio Ranucci (OICE, Italy)
- Jørgen Storm Emborg (FRI, Denmark)
- Antonio Vettese (OICE, Italy)

Thanks go also to Alison Eades (Archway Communications) for her journalistic input.

1. Introduction

Building information modelling (BIM) is a digital information management approach being adopted by the construction industry to improve productivity and quality in building and infrastructure projects, reduce financial losses during construction, and provide a basis for developing future services. At its core is 3-D modelling with embedded data that can be shared by and amongst all project partners, at all stages of a project from design through to maintenance. Each partner retains responsibility for their own data but project managers are able to use BIM as one 'agreed source of truth' for their decision-making. This means a more efficient use of resources, more effective communications and therefore collaboration within the partnership, greater flexibility and improved long-term planning – the benefits of which accrue to client, project manager and contractor.

Public and private sector clients are increasingly demanding their projects are realised on a BIM platform. Despite some countries adopting it at a faster rate than others, there is consensus that the world's built-environment will benefit dramatically from the potential inherent in BIM to improve its social and environmental performance. BIM is key in the pressing search for more sustainable solutions and is already moving towards becoming an industry wide approach at a global level.

Within this context, international standard ISO 19650 was published in 2018 to support BIM and encourage its wider use. It is therefore timely for the European Federation of Engineering Consultancy Associations (EFCA) to provide guidance to its members for introducing the standard and highlighting its far-reaching benefits. For engineers, BIM under the ISO 19650 concepts represents unprecedented opportunities for improving their added value during the construction process. This EFCA booklet will explain why.

THIS BOOKLET IS DIVIDED INTO FIVE SECTIONS

- Section 1** > Introduces BIM and relevant ISO standards
- Section 2** > Describes concepts of ISO 19650 Parts 1 and 2
- Section 3** > Describes relevant issues not covered by ISO 19650
- Section 4** > Describes the BIM execution plan
- Section 5** > Explains potential impacts of using BIM in contracts

THE APPENDICES HOLD THE FOLLOWING INFORMATION

1. References to BIM guidance in Europe (links)
2. Exchanging and sharing (container) information
3. Reference to BIM guidance in Europe (link)
4. Table of project and task information management functions

1.1. ISO 19650 and BIM

The International Organization for Standardization (ISO) published ISO 19650¹ in December 2018 as the standard for organising ‘information about construction works. It

“sets out the concepts and principles for the business processes across the built environment sector in support of management and production of information during the lifecycle of built assets, referred to as ‘information management’ in the text, when using building information modelling.”

And explains that:

“These processes can deliver beneficial business outcomes to asset owners/operators, project clients, their supply chains, and those involved in project funding including reduction of risk and reduction of cost through the creation and use of asset and project information models.”

An EU BIM Task Group Handbook² refers to ISO³ for a consistent description of BIM as:

“A process or method of managing information related to facilities and projects to coordinate multiple inputs and outputs, using shared digital representations of physical and functional characteristics of any built object, including buildings, bridges, roads, process plant.”

The Task Group recognises a major benefit of using BIM in its following ‘lesson learned’:

“The overall result was that designers worked according to strict and clear instructions regarding the detail, granularity, content and structure of the data they had to generate. The process contributed to a more reliable and coherent design delivery process.”

In this EFCA publication, the definition of BIM is taken from ISO 19650:

“The use of a shared digital representation of a built object (including buildings, bridges, roads, process plants, etc.) to facilitate design, construction and operation processes to form a reliable basis for decisions.”

1 ISO 19650-1:2018 Organization and digitization of information about buildings and civil engineering works, including building information modelling (BIM) -- Information management using building information modelling -- Part 1: Concepts and principles <https://www.iso.org/standard/68078.html>

2 EUBIM Task Group. (2017). Handbook for the introduction of Building Information Modelling by the European Public Sector: Strategic action for construction sector performance: driving value, innovation and growth. www.eubim.eu.

3 ISO/TS 12911:2012(en) Framework for building information modelling (BIM) guidance (<https://www.iso.org/obp/ui/#iso:std:iso:ts:12911:ed-1:v1:en>)



1.2. Aims of publication

The publication addresses the new ISO 19650 standards and their relevance to consulting engineers. It describes the beneficial outcomes of using them within the BIM approach, and from a project management perspective. It highlights the benefits of lowering risk and reducing financial losses which are possible where reliable project information is available in a structured, re-usable form and where it is efficiently shared. It illustrates how, by managing the ownership and liability of project data, project managers can stay in control during the whole lifecycle of assets, including operations and maintenance, experiencing less contradiction or misinterpretation of data.

It supports Part 1 and Part 2 of ISO 19650 which relate to concepts and principles. ISO will publish guidance to support Part 2 which explains these concepts for the delivery phase.

2. ISO 19650 Standard

2.1. Introduction

The introductory chapter to the ISO 19650 standard explains key concepts and benefits to project management. BIM is presented not only as a 3D tool for managing digital information but also as a new approach to managing projects where digital information is being exchanged between contract parties at all stages of a project, including design, procurement, commissioning and construction.

The outcome of BIM is a 'digital twin' of the asset to be constructed. This is a digital replica of the future physical system and is used for both development and design. It also provides a basis for developing new services, or new ways of using the asset, as well as for future maintenance.

BIM provides an opportunity to better manage the exchange of information, to use improved tools for checking quality, and to improve trust in the information exchanged. It increases productivity for designers and consulting engineers as they make increasing use of its many possibilities in information management. The BIM processes are also a way to engender confidence amongst the various parties of any project. By promoting true collaborative working, the use of BIM processes are already helping to strengthen mutual understanding and trust.

Both ISO 19650 Part 1 and Part 2 are oriented towards the design and construction phases of a project⁴, and are primarily intended for use by:

- those involved in the procurement, design, construction and/or commissioning of built assets; and
- those involved in delivering asset management activities, including operations and maintenance.

The standard has not been produced just for large, complex projects, it is:

“applicable to built assets and construction projects of all sizes and all levels of complexity⁵.”

However, only the issues mentioned in this section will be discussed in this EFCA publication as they are the ones relating to the standard business models used by consulting engineers represented by the EFCA member associations.

⁴ The asset management phase will be described in a dedicated and additional part of ISO 19650

⁵ ISO 19650-1:2018

2.2. ISO 19650 ‘Part 1: concepts and principles’

Part 1 of ISO 19650 refers to the ‘concepts and principles’ needed to develop BIM processes in a contract.

2.2.1. ISO 19650 in the life cycle



Figure 1: Information management lifecycle as it relates to ISO standards, according to ISO 19650

Figure 1 shows the general information management life cycle for operational assets and project delivery, and the relationship between these two distinct parts of the asset life cycle, within ISO standards 9001 (quality management) and 19650.

The Figure shows ‘A’, the start of the delivery phase which, in an asset life cycle, refers to the asset information model requirements’ impact on the design, construction and commissioning of that asset. It also shows ‘B’ as the phase with progressive development of the design intent model into a virtual construction model, as part of a ‘digital twin’ – the digital replica of the physical system. ‘C’ shows that handover is a bridge between the construction process and the operational phase.

KEY

- A Start of delivery phase – transfer of relevant information from AIM (Asset Information Model) to PIM (Project Information Model)
- B Progressive development of the design intent model into the virtual construction model
- C End of delivery phase – transfer of relevant information from PIM to AIM

2.2.2. Definitions used in project management

(a) Building Information Modelling

Use of a shared digital representation of a built asset to facilitate design, construction and operation processes to form a reliable basis for decisions

Using BIM and both Parts of ISO 19650, consulting engineers can demonstrate, in real time, the relevancy and the compliance of their design. The concept of ‘shared information’ relates to the possibilities in BIM of using digital information to simulate and display the project at each stage of development. Sharing this structured information with all relevant parties also facilitates the decision-making process, including final approval. Using open standards to structure the information allows it to be shared more easily.

(b) BIM Execution Plan

Plan that explains how the information management aspects of the appointment (3.3) will be carried out by the delivery team (3.17)

A BIM Execution Plan (BEP) defines how, why, when and by whom the information modelling aspects of the contract will be carried out. The use of BIM should be clearly agreed with the client and specified in the contract alongside the ‘needs’ which fulfil the agreed contractual obligations.

A BEP should be considered part of the quality architecture of a project in addition to, or implemented in, the Project Management Plan. It should detail not only how information is created and delivered, but also the ‘why’ (defining the BIM use), and the ‘who’ (assigning responsibility for it). ISO 19650 - Part 2, which concentrates on the delivery phase of the assets, provides some help in defining the ‘how’ and the ‘who’. The ‘why’ is usually part of the guidance for implementing the BEP in the definition of proposed BIM uses.

(c) Level of information need

The level of information need is:

Framework that defines the extent and granularity of information.

Note 1 to entry: One purpose of defining the level of information need is to prevent delivery of too much information.

It has to be noted that the ISO committee has decided to refuse to use any acronym for this, to underline there is no tool for that. In the same way, “level of information” is always used with the word “need”.

In the past, with drawings, the ‘granularity’ of information was determined by scale or by a person’s capacity to draw and to read a line on a drawing. Standards such as BS (British Standard) then specified the information to be attached. With digital information, however, there is no physical limitation. The purpose drives the information to be embedded in the model. The level of information need is therefore developed to assure that the information is implemented in the model at the time it is needed to fulfil its purpose. It should take into account the specificities of data drops, domains and BIM uses which cannot be covered by single parameters, such as level of development (LOD coming from BIM Forum⁶) or level of detail (LOD coming from CityGML⁷). The European Committee for Standardization (CEN) is publishing a guidance document to support the level of information need concept.

6 BIM Forum : <https://bimforum.org/2018/12/04/2019-draft-lod-specification-released-for-public-comment/>

7 CityGML: <https://www.opengeospatial.org/standards/citygml>

(d) Information container

named persistent set of information retrievable from within a file, system or application storage hierarchy

EXAMPLE Including sub-directory, information file (including model, document, table, schedule), or distinct sub-set of an information file such as a chapter or section, layer or symbol.

This concept is important and to be associated to the Level of information need. The process of digital information delivery needs to associate different sources of information, which are not geometry only.

2.2.3. Two key concepts for consulting engineers

(a) Common Data Environment

Agreed source of information for any given project or asset, for collecting, managing and disseminating each information container through a managed process.

The concept of a ‘common data environment’ (CDE) comes from standard BS 1192:2007⁸ and itself refers to three further concepts:

- ‘workflow’ – work in progress (WIP) or work approved regarding the status of information
- ‘lifecycle’ – work in progress shared, published, or archived
- a ‘shared and single source’ of information

Having a CDE is fundamental for consulting engineers if they are aiming to improve:

- productivity, or
- trust and confidence

ISO 19650 describes the CDE as a single source of information for any given project or asset which is used to collect, manage and disseminate each element of the information model using a managed process. It is a means of providing a collaborative environment for sharing and coordinating work as information can be transferred through information exchanges and managed through the CDE. Strict operating procedures ensure a consistent approach by all organisations involved.

8 BS 1192:2007 Collaborative production of architectural, engineering and construction information – Code of practice (<http://bim-level2.org/en/standards/>)

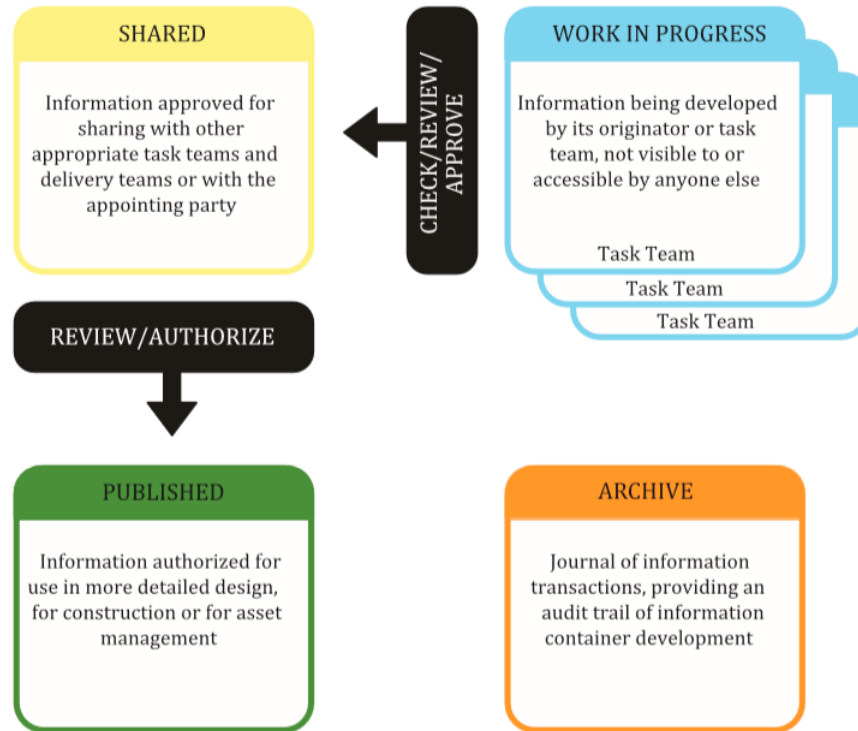

Figure 2: The structure of a Common Data Environment, according to ISO 19650

A CDE should be adopted to allow information to be shared between all parties involved, across the asset lifecycle in delivery and operation of built assets. Productivity improves by sharing digital information and thereby improving collaboration between parties. It reduces the need for hard copies of deliverables, it re-uses information and it prevents the use of unreliable or obsolete information thereby reducing financial losses. All the information, data and metadata can be verified in real time.

It is important to consider security and data quality and integrate appropriate protocols in the CDE.

(b) Requirements management

The purpose of having information requirements is to specify the information that the asset or project supply chain members need to deliver as part of their work. They will be stored in the asset information model or project information model respectively. The different types of information requirements are shown in Figure 3.

Information Requirements management represents one of the main concepts of ISO 19650: BIM is a process of information delivery in accordance with requirements management coming from the systems engineering approach, developed for other industries. It includes:

- **Organisational Information Requirements (OIR)** – those pieces of information needed to answer or inform high-level strategic objectives within the asset owner/operator in relation to the built assets owned, operated, used or managed by them.

- **Asset information requirements (AIR)** – those detailed pieces of information needed to answer the organisational information requirements.
- **Project information requirements (PIR)** – those pieces of information needed to answer or inform high-level strategic objectives within the asset owner/operator or project client organisation, in relation to a particular built asset project.

ISO 19650 - Part 2 provides some key concepts for delivering information and, reinforcing BIM, a strong improvement in mitigating risks related to liability and intellectual ownership of information.

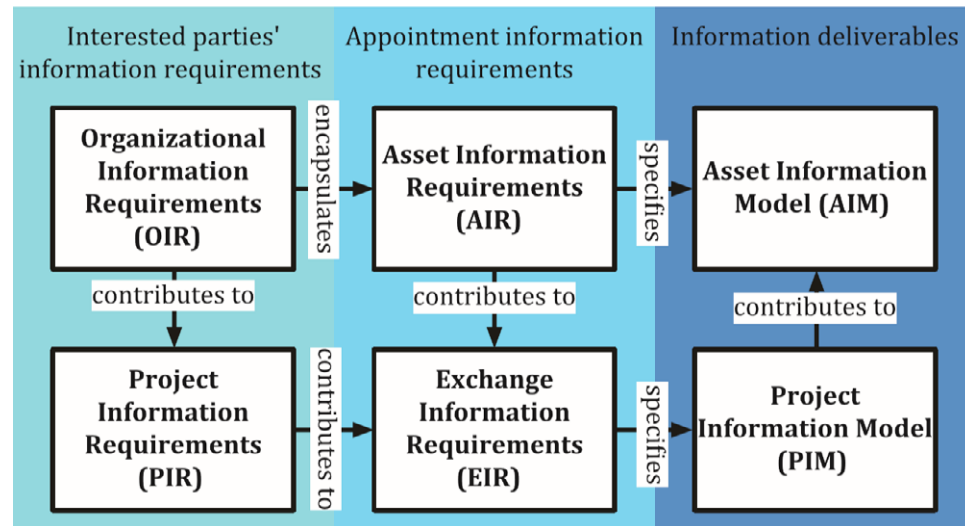

Figure 3: Different types of information requirements and information models, according ISO 19650

2.3. ISO 19650 Part 2: 'Delivery phase of the assets'

ISO 19650 - Part 2 explains a set of processes for information delivery in the cycle of design, construction and handover including those relating to tasks, roles and responsibilities, as well as the identification and assignment of accountable parties for each activity and task.

Figure 4 sets out the crucial elements for managing a process of information delivery. It includes:

- appointing party and appointed party
- information process to communicate or to share information

The figure shows a traditional organisation for a project: the appointing party (the client) and the appointed parties (the consultant or contractor). Information flows from C to B, rather than C to C, and then B to A, or B to B, depending on the contract.

It has to be noted that neither the role of BIM manager nor of the coordinator are described in the final release of ISO 19650 - Part 2. However, Section 5.3.2 identifies information management tasks for the appointed party within the tender response:

In doing this, the prospective lead appointed party shall include:

a) the proposed names and professional résumé of the individuals who will undertake information management functions within the delivery team;

b) the delivery team's information delivery strategy, containing:

— the delivery team's approach to meeting the appointing party's exchange information requirements, (..)

Role titles might differ from project to project depending on market sector, project size and the supply chain tier but the important factors are in the process of delivery including ownership, responsibility and authority. In smaller businesses, many of these roles might be executed by the same individual. The organisation can differ project by project, nevertheless the delivery tasks remain.

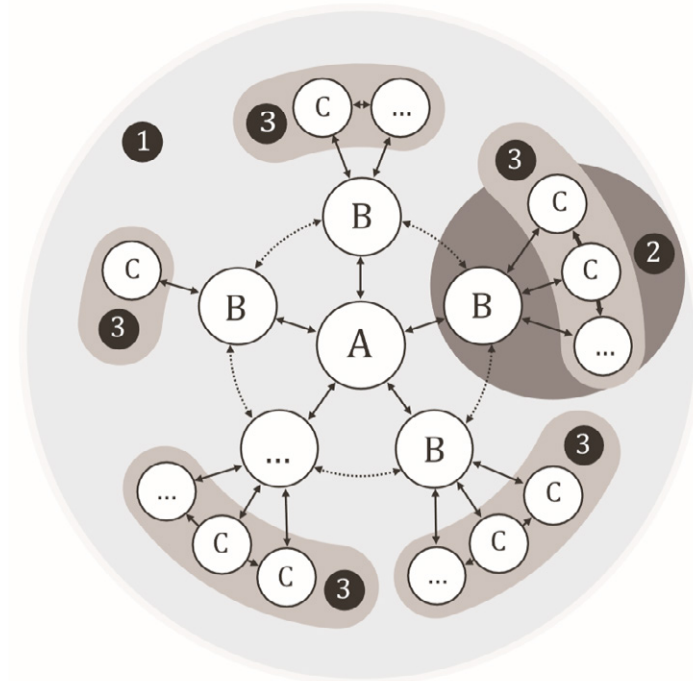

Key

- A appointing party
- B lead appointed party
- C appointed party
- ... variable amount
- 1 project team
- 2 illustration of a delivery team
- 3 task team(s)
- ↔ information requirements and information exchange
- ⬅➡ information coordination

Figure 4: Interfaces between parties and teams for the purpose of information management (ISO 19650 - Part 2)

The process of delivery, according to ISO 19650 Part 2, Section 4.1 Information management process, is detailed in the figure below.

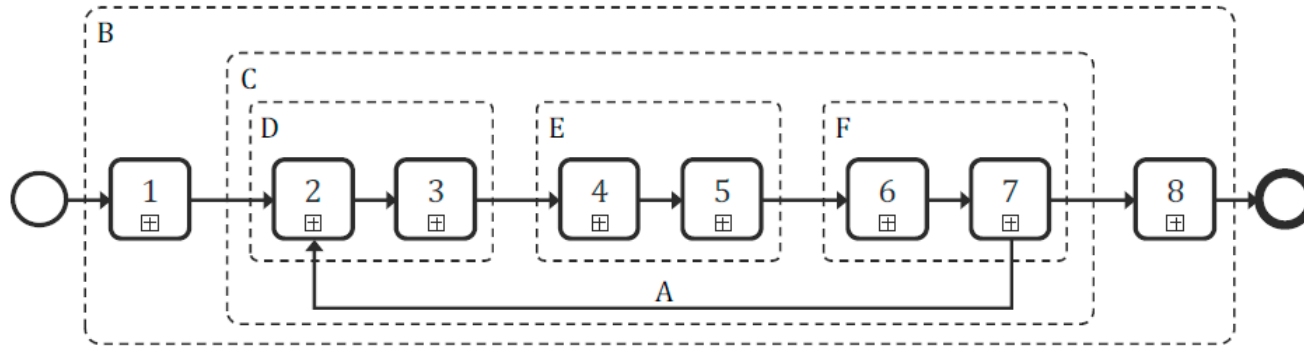

KEY

- 1 assessment and need
- 2 invitation to tender
- 3 tender response
- 4 appointment
- 5 mobilization
- 6 collaborative production of information
- 7 information model delivery
- 8 project close-out (end of delivery phase)

- A information model progressed by subsequent delivery team(s) for each appointment
- B activities undertaken per project
- C activities undertaken per appointment
- D activities undertaken during the procurement stage (of each appointment)
- E activities undertaken during the information planning stage (of each appointment)
- F activities undertaken during the information production stage (of each appointment)

Figure 5: Information delivery process with Stages 1-8, according to ISO19650 - Part 2

Two aspects should be noted:

- the starting point is the specification of requirements, Stage 1: Assessment and need
- the final point is project handover, Stage 8: Project close-out

Consulting engineers are affected at an early stage, Stage 3: Tender response.

It is important to note that Figure 6 shows project closure happening differently:

- where a contract is design only
- where a contract includes works supervision, i.e. usually between the client, the consulting engineer and the contractor
- where a contract includes the handover

Figure 6, below, shows the relationship between these three parties: client, consulting engineer and contractor. However, each country treats work breakdowns structures differently and they should be developed accordingly.

With Figure 6, ISO 19650 - Part 2 strongly recommends the client to prepare the tender process by specifying in the tender documentation its requirement for the information delivery process. Consulting engineers should note the impact on the tender documentation (Stage 3) i.e. the BEP is prepared during the bidding process in order to have a clear understanding between the appointing and appointed party, before the commencement of the project.

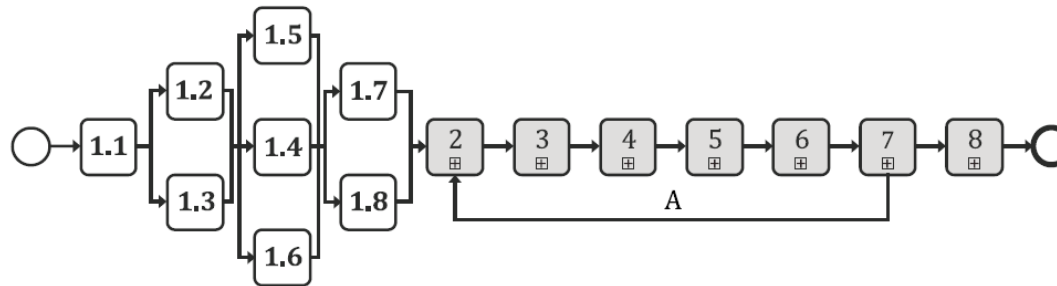

KEY

- 1.1 appoint individuals to undertake the information management function
- 1.2 establish the project's information requirements
- 1.3 establish the project's information delivery milestones
- 1.4 establish the project's information standard
- 1.5 establish the project's information production methods and procedures
- 1.6 establish the project's reference information and shared resources
- 1.7 establish the project's common data environment
- 1.8 establish the project's information protocol
- A information model progressed by subsequent delivery team(s) for each appointment

NOTE Activities shown in parallel are to highlight that these activities can be undertaken concurrently and apply to all instances

Figure 6: Information delivery Stage 1 – assessment and need, according to ISO 19650 - Part 2

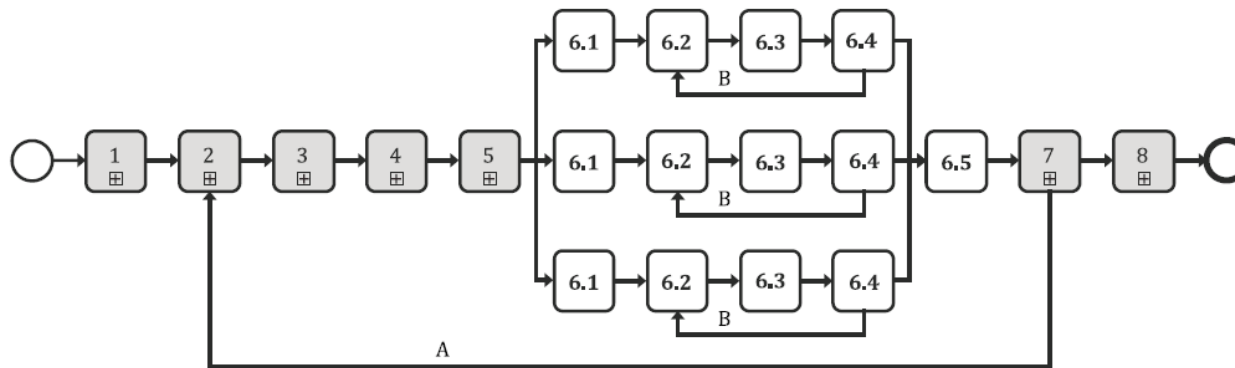

KEY

- 6.1 check availability of reference information and shared resources
- 6.2 generate information
- 6.3 complete quality assurance check
- 6.4 review information and approve for sharing
- 6.5 information model review
- A information model progressed by subsequent delivery team(s) for each appointment
- B new information container revision

NOTE 1 Activities shown in parallel highlight the production of information by each task team prior to the information model review.

NOTE 2 The information model review undertaken in 6.5 can be repeated until such time as the information model is ready to be submitted for lead appointed party authorization.

Figure 7: Information delivery Stage 6 – collaborative production of information, according to ISO 19650 - Part 2

Figure 7 describes the process for integrating a BIM approach in to quality assurance and the quality check of the information delivery. This is an important process for improving productivity and for building confidence. It helps to understand the sharing process of the CDE, and to develop the idea of producing deliverables further to the approval under a BIM project review.



3. Important issues for managing BIM (but not covered by ISO standards)

3.1. Project management and BIM

The implementation of BIM as a methodology gives the best result by far when the quality of the information deliverables is improved and when the collaboration is enhanced in a structured way and integrated into the project management process.

It is essential that the project management process remains the same as always, with all necessary underlying knowledge and experience. BIM brings additional tools, metadata and concepts to the same fundamental traditional processes of design, planning, tendering, execution, communication and coordination. This naturally leads to improvements in reducing financial losses, saving time, improving quality and mitigating risks.

The BIM approach supports the agile and lean principles for better planning of both inputs and deliverables. It improves communication and interoperability between different stakeholders and different project phases and leads to an integrated approach for changes and optimisations.

3.2. Processes

ISO 19650 explains processes in general terms. However, there are some key issues for the engineering and construction phases of BIM-enabled projects of which consulting engineers should be aware:

- the defined process must allow for developments in the project and any changes this creates to the deliverables, etc.
- the role of the BIM manager is not defined in the ISO 19650 and depends of the country, the contract, the companies. The role of the BIM manager in a project team varies across companies, It has to be considered as a role, associated to the appointed party in the contract, including the processes of BIM management with the responsibility of the BEP, the information management, the information requirements management , the information workflow management and

- the information interfaces management. Even, if it is not a full-time activity, a member of the project management team has to be appointed for these responsibilities.
- the importance of defining the process for exchanging information between all stakeholders

The frequency and quality of the information exchange and sharing is crucial to the success of a BIM project and should be brought in line with the expected deliverables. The BIM model, the 'digital twin', is a merger of different models and acts as a single source of truth for all information derived from it.

In order to ensure fast convergence of the BIM model towards a final design that complies with requirements, and ultimately with the reality of the asset, it is advisable to only share the information that is necessary to be shared at that particular moment, with other stakeholders.

The BIM management is to organise the following tasks, and their implementation under the BEP:

- to merge all discipline models
- to check the compliance of the models according to the BEP or other agreement
- to check the evolution of the models and their compliance with the scope of work
- to check for clashes between the models

After defining, in the BEP, the actions needed under the design contract, together with the project manager or the steering team, the BIM Management has to communicate the decided actions to all stakeholders. The process repeats itself on an agreed frequency until consensus or goal per project phase has been reached and the design can be published.

As a result of the above, the BIM process creates greater communication and visibility around project progress for all stakeholders and so supports project management in a positive way. However, it requires a mind-set of sharing and transparency that is not always common in traditional projects, nor amongst many stakeholders across the whole construction sector.

It is worth mentioning that this process also requires a much closer involvement of the client during all project phases, and specifically regarding approval after each phase which is necessary for being able to converge towards a final design.

During the operational or maintenance phase, the amount of interaction with different stakeholders will usually be less than during the project phase, so the above is advisable only on a need-to-have basis. This phase is getting more and more about enriching the BIM model with additional information and using this information for innovative approaches (Internet of Things, Smart Buildings, Smart Cities, etc.) and maintenance or for operational purposes.

3.3. Common Data Environment

During the lifecycle of an asset, there is a continuous flow of information. The CDE captures, controls, manages and shares this information (called ‘metadata’ by ISO 19650) throughout.

Cf. Figure 2: Lifecycle information management via a Common Data Environment – ISO 19650 Part 1

The evolving 3D and BIM software can carry out tasks related to:

- document management, including revision control
- access rights to information
- workflow, log books, audit trail, progress control, cost control
- connection to corporate systems, e.g. for financial data
- project communication, e.g. with communication through email, pdf files, etc.
- BIM tools like viewers, clash detection and code checking, etc. (also supports communication between stakeholders)
- up-to-date information take-off
- adding separate graphical and non-graphical information
- maintenance and facility management

The transition from file-based to model-based project implementation has led to a change of work methodology and interaction patterns. The models are 10 to 100 times larger than the previous model files, and calculations are performed directly in the models. This has resulted in new requirements for storage capacity, file sharing and accounting capacity. The requirements for infrastructure, hardware and software are increasing exponentially and software vendors have changed their strategies to comply with the new requirements. Cloud-based solutions are increasing storage capacity, distributing software and databases (weather and climate data, IoT) and interacting with projects across multiple companies without having to open-up.

Cloud applications are owned by software vendors and are strongly linked to their platform. The number of places where the data are stored therefore increases with the number of applications and their cloud-based solutions that are used in a project. Not every application is flexible in including formats for which vendors do not have ownership, and many solutions cannot use storage sites for which they do not have full control. An open format for CDE, the use of open standards, and linked information applications, based on international open standards, via open accessible ‘platforms’, while taking care of data security, data protection as well as protection against the misuse of data, will help to prevent the issue described above.

3.4. Exchanging/sharing information in a BIM process

To facilitate the use of BIM and the exchange or sharing of digital information between clients and suppliers across the project and asset lifecycle, regulatory, procurement and legal aspects should be considered to clarify the terms relating to:

- hierarchy of the information
- intellectual property ownership
- obligations and liabilities of suppliers
- purpose of information exchanges
- roles and responsibilities for information management

BIM information can be shared via 'containers' according to the ISO 19650 fundamental principles of container-based collaborative working to be achieved. That is collaborative working across an asset or project team using containers for sharing asset or project information. An example of a container-based collaborative way of working is in the open standardised 'COINS'⁹ container, using an information delivery manual (IDM) to describe the exchange requirements. ISO 10303 STEP 239¹⁰, developed by the manufacturing industry, can also be considered as an example of a multicontainers standard. See Appendix 2 for further details.

⁹ Constructive objects and the integration of processes and systems

¹⁰ ISO10303 Step 239: Product Life Cycle Support

3.5. Effective BIM implementation from a project manager perspective

The four major criteria of any project – cost, time, quality and risk – are the main parameters that quantify the success of BIM implementation. From an engineering consultant and project manager perspective, effective implementation of BIM means primarily focusing on using BIM as a tool for staying within the planned budget and timeframe, without clashes and problems in design, unplanned works, reworks, claims, unrealistic deadlines, etc.

BIM is facilitating project management and quality control through processes and tools. Automated and semi-automated quality control procedures are available using BIM tools for different BIM uses in different project stages.

It is essential that project managers on BIM projects fully understand the BIM process and know how to use the model to track progress as it is different from traditional projects. It is, for example, impossible to track progress using numbers of completed drawings on a BIM project.

Having project managers in line with BIM, means to integrate its principles and technology into various project processes and to utilise the enhanced level of information for decision-making, quality control and effective risk mitigation.

Effective BIM implementation requires a lean, start-with-the-end-in-mind approach, which involves project requirements, delivery and contract type, the number of stakeholders and existing infrastructure and buildings. Information which is entered and not used is considered waste, but too little information can inhibit some later BIM uses and analyses.

The BIM model itself, the ‘digital twin’, is the basis of information for most of the BIM uses derived from it, and since this is the case, the information requirements for it should be precisely defined having in mind all subsequent uses of the data, further input, process and software requirements, etc.

The defined information requirements for each of the BIM deliverables should take into account the software output interoperability between deliverables and should ensure the outputs from one procedure can be utilised as inputs and references of another – a piece of information entered once should propagate through the process and be used to the highest extent.

The process of defining information requirements and information handshakes should apply the principles of systems engineering. This means that information is not lost to another participant in the project, and that collaboration is enhanced not only between immediate co-workers and co-participants, but between stakeholders who will not have direct contact with each other on the project (e.g. designers and facility managers on some projects which follow a waterfall design-bid-build-operate method). This dramatically improves the quality of deliverables, making obsolete documents and miscommunication highly unlikely, with communication being enabled through the BIM model itself.

When project management processes are linked with BIM uses, deliverables and information management, the true value of the BIM model as a single source of truth can be fully harnessed.

The slight initial expense in the transition process is usually covered through mitigated risks and saved unplanned work. Although one should bear in mind that these types of expenses are hard to estimate and even harder to prove, thus sometimes making calculating return on investment difficult.

Risk management is a standard responsibility of project managers, as well as a concern for investors and contractors, which can also benefit from BIM uses. Much of the risk related to the quality and synchronisation of design, obsolete or imprecise quantities, undefined or out-of-scope works, unrealistic schedules, unplanned rework due to collisions, bad cost estimates, can all be severely reduced and mitigated with proper implementation of BIM as a tool for these estimates or a tool for quality control. This can result in more realistic schedules and cost estimates, less unpredictability, and even less risk margins with bidding and tenders.

3.6. BIM deliverables – reusability

BIM deliverables, inputs and their respective structures, should be implemented as stated in ISO 19650 - Part 1 (Section 6), following the information lifecycle concept and setting information requirements with information delivery in mind. This means every participant in the supply chain should adhere to the information handover principles for the BIM model and related deliverables, to induce not only horizontal collaboration within a single project phase or set of participants, but also to enable reuse of this data for participants further along the project pipeline. This is especially true with the 'single source of truth' concept of the BIM model, and should be further amplified with the CDE and proper definition of project processes.

More specifically, BIM deliverables are to be defined in a lean way – each deliverable should have a clear task at improving the main project features – cost, time, quality and risk. Deliverables should be able to be used and re-used throughout the project lifecycle, avoiding the need for re-entering (essentially waste in lean terminology) information that was already present in a way but is unusable due to technical (software, format etc.) or legal (rights, availability) restrictions. Each deliverable should be structured in line with existing project management processes, with clear quality control and assurance procedures, and workflow instructions on where it will be reused later in the lifecycle and what will be the necessary information handover and requirements for it.

In all projects, especially larger ones with multiple disciplines and numerous stakeholders, it is crucial to enable interoperability by ensuring that all results and useful information can be opened, read, reviewed and further used by any entity involved. There is an increasing number of new software features and capabilities. All information should be prepared for future, unanticipated uses.

This is further exemplified through the following figure where it is shown that, in a traditional setting, significant information about the project is lost between different phases, and this is true for between different stakeholders as well.

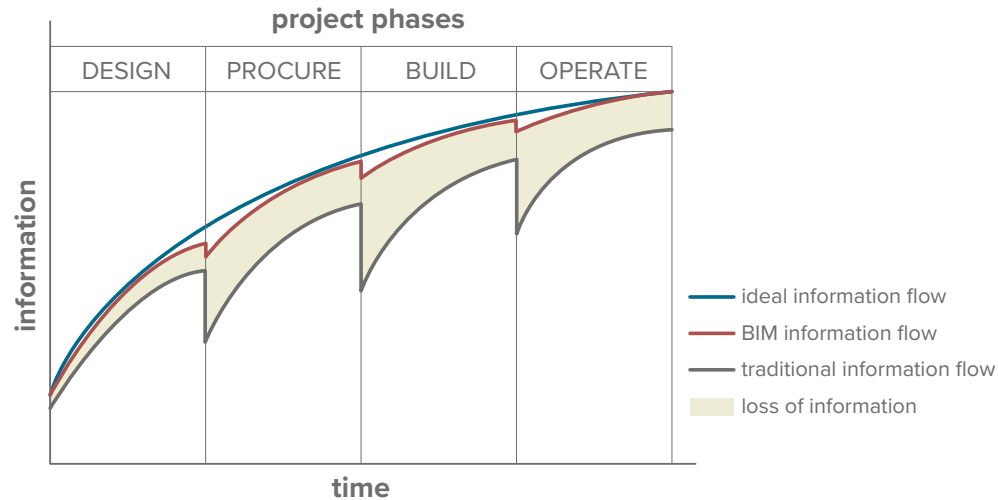

Figure 8. Knowledge base throughout the project lifecycle¹¹

With an agreed source of knowledge in the form of a BIM model, information is better communicated and remains within the knowledge base even after stakeholders who have implemented this knowledge have finished with their involvement in the project.

The interoperability should be available for both the baseline data (BIM model, through the ISO 16739:2013 Industry Foundation Classes standard) and analyses results (clash detection, cost simulations BIM5D, construction simulations BIM4D).

Current open formats should be extensively utilised, as they will be the basis for most open formats in the future (most of them have existed for many years and have had several iterations and versions, gaining popularity and user base along the way):

- ISO 16739:2013 Industry Foundation Classes (IFC), as well as the newer IFC 4 with 4D/5D support and oncoming version IFC 5 with infrastructure support (with buildingSMART International being the main organisation working on this format)

¹¹ Source: Eastman, C., Teicholz, P., Sacks, R., & Liston, K (2011). BIM Handbook: A Guide to Building Information Modeling for Owners, Managers, Designers, Engineers, and Contractors. Hoboken, NJ: John Wiley & Sons.

- BCF (Open BIM Collaboration Format) – for clash detection and viewpoints (buildingSMART)
- CityGML – for digital models of cities and urban areas (Open Geospatial Consortium OGC)
- Other formats in the openBIM initiative for further BIM analyses, including QTO, time schedules, cost estimates, operations and maintenance data, sensory data etc.

These formats are currently either in development or in the planning and definition phases and should be supported officially through standardisation bodies, buildingSMART and OGC.

Interoperability definitions should be available for any project container utilised for collaboration, as defined in the ISO 19650 – Part 1 (Section 8). They allow for having deliverables which are independent from software vendors. In order to ensure the required interoperability, it is recommended to use software that supports open standardised formats and which are certified by relevant organisations, such as buildingSMART IFC Certification.

The Project Execution Plan, the BIM Execution Plan, and project contracts, should specify the desired open formats from the beginning, as the planned end-results and deliverables should be readable for the client and any future potential participant, without having to incur additional costs.

This means using all open formats available for defining the deliverables, along with sample files for evaluating readability and usability of the end deliverables. If open formats are not readily available for a set of analyses, the specific format should be mutually agreed, and other variants of the format should be explored (e.g. other proprietary formats which can be read using an application or software development kit (SDK) as a set of software development tools that allows the creation of applications for a certain software package, software framework, hardware platform, computer system, video game console, operating system, or similar development platform).

Under the BEP approval process, all sample files should be evaluated by the client and approved officially prior to a specific phase of the project. The pre-approval of all formats vastly reduces interoperability risks and synchronization and conversion time and improves usability of future deliverables.

The CDE vendor should be approached for an open source format as well, for potential migration and backup of versioned project data. This format should be defined and further developed, which could be done as a proposal or in collaboration with some of the openBIM initiatives.

All open formats and standards should be a part of the client's information requirements, especially for the asset information requirements for operations and maintenance use.

3.7. Education and training

The development of BIM has led to new work processes and new ways of interacting in projects. This again has led to new definitions and terminology for which we need to establish a common understanding.

To ensure that all employees know and understand how a BIM mind-set influences all project processes, it is important to educate the whole organisation. The training must be related to the function each employee has, or the role they possess, both in the company and in projects. Key issues include:

- to calculate a tender and deliver a bid it is necessary to understand the legal and economic implications of what is being requested and which deliverables are to be included;
- to manage a BIM project, it is necessary to understand the new ways of interaction and deliverables for each stakeholder and how to use BIM technology to manage time, quality, cost and risk;
- to prepare for BIM project execution it is important to appoint a BIM manager for the project to match project setup to the contract requirements and to clarify if anything is not specified;
- a designer needs to learn how to implement more of the information into the model, instead of in separate documents, and to use the model throughout the process. The designer also needs to understand that the model is the main deliverable and therefore must be in the main focus of QA.

Once a national or international body of knowledge is established, BIM certification should certainly be a priority for dedicated BIM personnel and any individuals who will have direct control over the BIM implementation process.



4. BIM Execution Plan

4.1. Contents

The BEP is the main document concerning BIM implementation for a project and can be considered as an extension to the traditional Project Execution Plan (PEP). The BEP describes all aspects of BIM implementation on the project – from BIM uses and their integration into project management processes, over specific deliverables, analyses, interface management, communication and coordination plans facilitated by BIM, granulometry of the information to be delivered, to IT requirements, file formats and interoperability.

As said in ISO 19650 - Part 2, a pre-award BEP is issued at the tender stage, indicating which BIM uses, and what type and level of BIM implementation, will be delivered in accordance with the client requirements. A post-award BIM is one agreed by all relevant stakeholders, including the client, and which should reflect the actual procedures, deliverables and timeframe which are to be in effect during the project.

The content of a BEP could be different according to national practices. It is strongly recommended that published national guidance is referred to, for instance, from the international chapters of buildingSmart.



An example of a BEP content is listed below:

- BIM Project Execution Plan overview
- project information
- key project contacts
- project goals/BIM uses
- organisational roles/staffing
- software and its versions
- BIM process design
- BIM information exchanges and planning/timing related to these exchanges
- BIM and facility data requirements
- collaboration procedures
- quality control
- technological infrastructure needs
- model structure
- project deliverables
- delivery strategy/contract
- attachments

Special focus should be given to individual BIM uses, as they will be the key factors for aiding and improving standard project processes.

4.2. Level of information need

Two concepts for the description of the information to be delivered exist prior to determining the level of information need:

- (a) **The level of development issued by BIM Forum¹², and currently used in a number of projects across the world;**
- (b) **The level of detail issued by CityGML and used in the GIS domain**

These two concepts are not compatible and refer to the current way to provide information on drawings according to a reference scale.

Developing BIM uses and having a flexible approach in infrastructure projects drives the need to investigate different ways to deliver the relevant information, fit for purpose.

The level of information need refers to three main approaches not defined in the ISO 19650.:

- (a) **Level of geometry**

The geometric precision of the elements represented – which parts of the element can be ignored or simplified and while still keeping the element functional for BIM uses such as clash detection, An object can be represented as a line, a surface or a solid.

- (b) **Level of information**

The semantics to be attached to the object, including properties, material, etc..

- (c) **Level of documentation**

The kind of documentation to be associated to the object.

These three concepts are not exhaustive. For instance, the degree of accuracy of the level or its precision could be linked to the geometry or information. They have nothing to do with the status of the information in the delivery process (metadata) but the granularity of the information to be used for a dedicated purpose such as a BIM use or a data drop.

It is important to have these defined either through the common LOD standard, or as separate modelling guidelines (as an additional project information requirement), stating model segmentation requirements. For example, slab segregation into construction sequences, utilities segregation as per construction schedule fixes, etc..

The level of information need is a critical part of each BIM use, since the analyses and deliverables directly rely on information given in them.

BIM uses and deliverables depend on the information available in the BIM model. The level of information need related to the BIM uses and the list of data drops. should be defined from very early on in the project stages, and must be agreed upon by all project participants, as it will influence the amount of information later on in the project, and facilitate other BIM uses which might not be required immediately or even by the same stakeholders producing the BIM model. Furthermore, quality checks regarding these requirements must be integrated into standard quality control or quality assurance procedures and information delivery milestones.

ISO is working to publish a more detailed documentation to help implement the level of information need concepts in a standard way. Nevertheless, level of information need can be provided in a number of forms – the AIA BIM Forum and the BS/PAS have their own definitions of LOD as graphical or textual descriptions, and other projects use a more structural or descriptive approach. Some national guidance is emerging, with approaches based on similar concepts.

4.3. BEP and information management

The following flowchart is an example of project lifecycle, demonstrating which aspects and stages of the project the BEP relates to, and showing the mutual dependencies of specific BIM uses throughout the project. It also shows the expected BIM deliverables, and their mutual dependence during the project stages. Using this flowchart, the BIM uses should be analysed and fine-tuned to optimise their impact and significance.

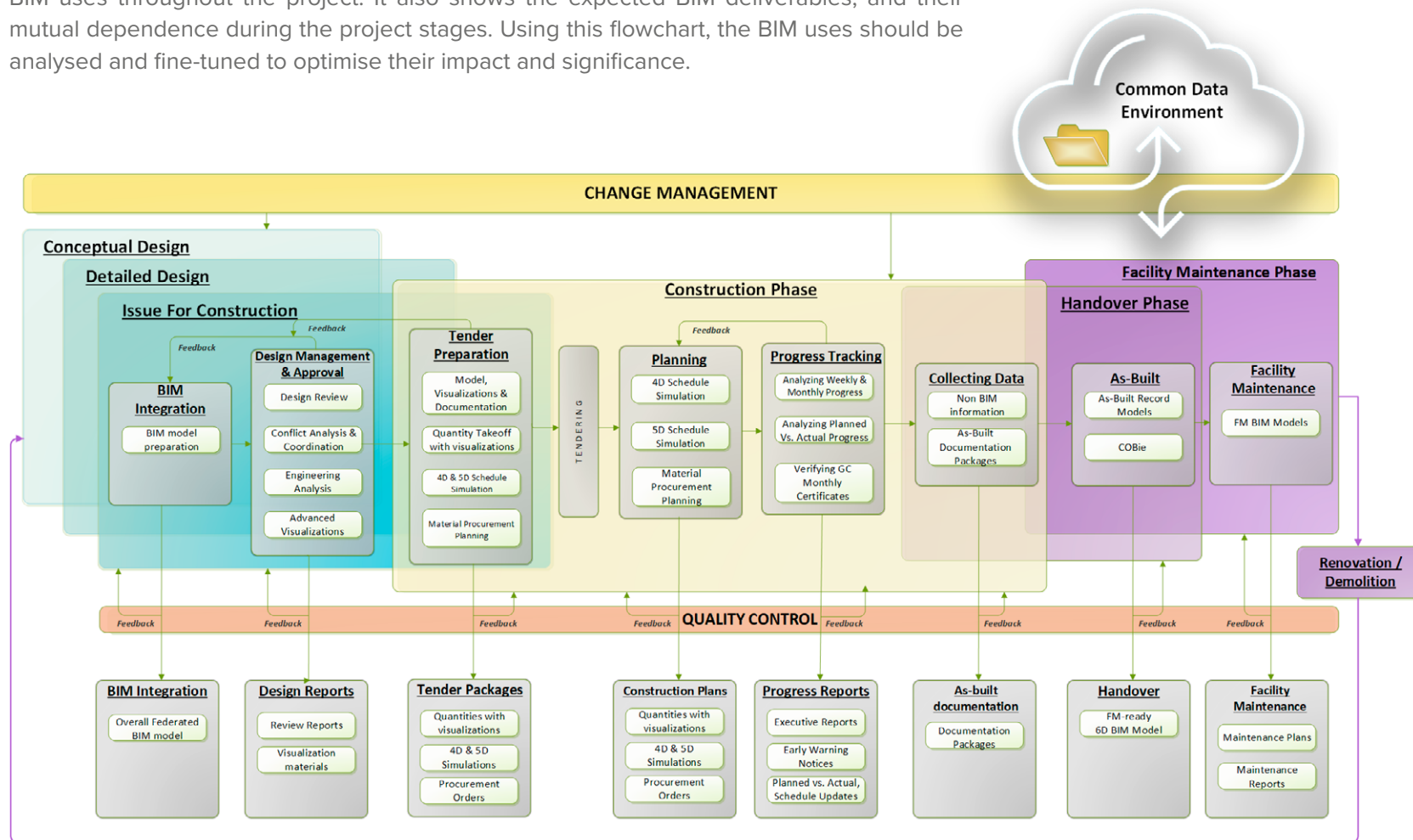

Figure 9. Flowchart illustrating lifecycle of a project and the coverage of a BIM execution plan (by courtesy of Bexel Consulting)

4.4. BIM uses

As already mentioned, the BEP has to be developed at a very early stage of a project. It not only explains how the information will be delivered but also, in accordance with the risk analysis, why. The BIM uses have to be selected in relation to the goals and requirements of the project and show real added value in the process of design and construction. This directly affects which BIM uses can be implemented in each project stage, as well as the results expected from them. How the uses are described is tightly related to the level of information need in order for them to be properly executed.

For the purposes of defining BIM uses and their correlation to specific project stages, an Information Delivery Plan is needed as a basis for project stage definitions, as per ISO 19650 – Part 2. Each individual BIM use is to be defined with a specific goal in terms of cost, time, quality or risk, related to the project or another secondary use.

Each use should reference a set of significant inputs or reference documents or information sets, such as: project stages, reference coordinates system, classification systems, engineering guidelines/standards, local requirements related to the project, etc. A set of other details should also be defined, as follows:

- project inputs – the input requirement necessary for each specific BIM use
- process integration – the workflow and stakeholders to be included in the process, along with integration into other project processes
- deliverables – the end results of the given process
- expected benefits – the reason that specific BIM uses are utilised on a project
- training and skills necessary for stakeholders to be able to execute or utilise the results of each specific BIM use
- technology deliverables – software vendors and types, files and formats and other technical information regarding the deliverables and their utilisation. This is tightly related to the section covering interoperability

BIM uses should not be an exhaustive list, since new uses are being developed and the existing ones improved, but the aim of this section is to list some of the most common usage and some of their benefits.

As already mentioned, it's strongly recommended to refer to national guidance, published for instance by buildingSmart international chapters, to introduce BIM uses in specific BEP.

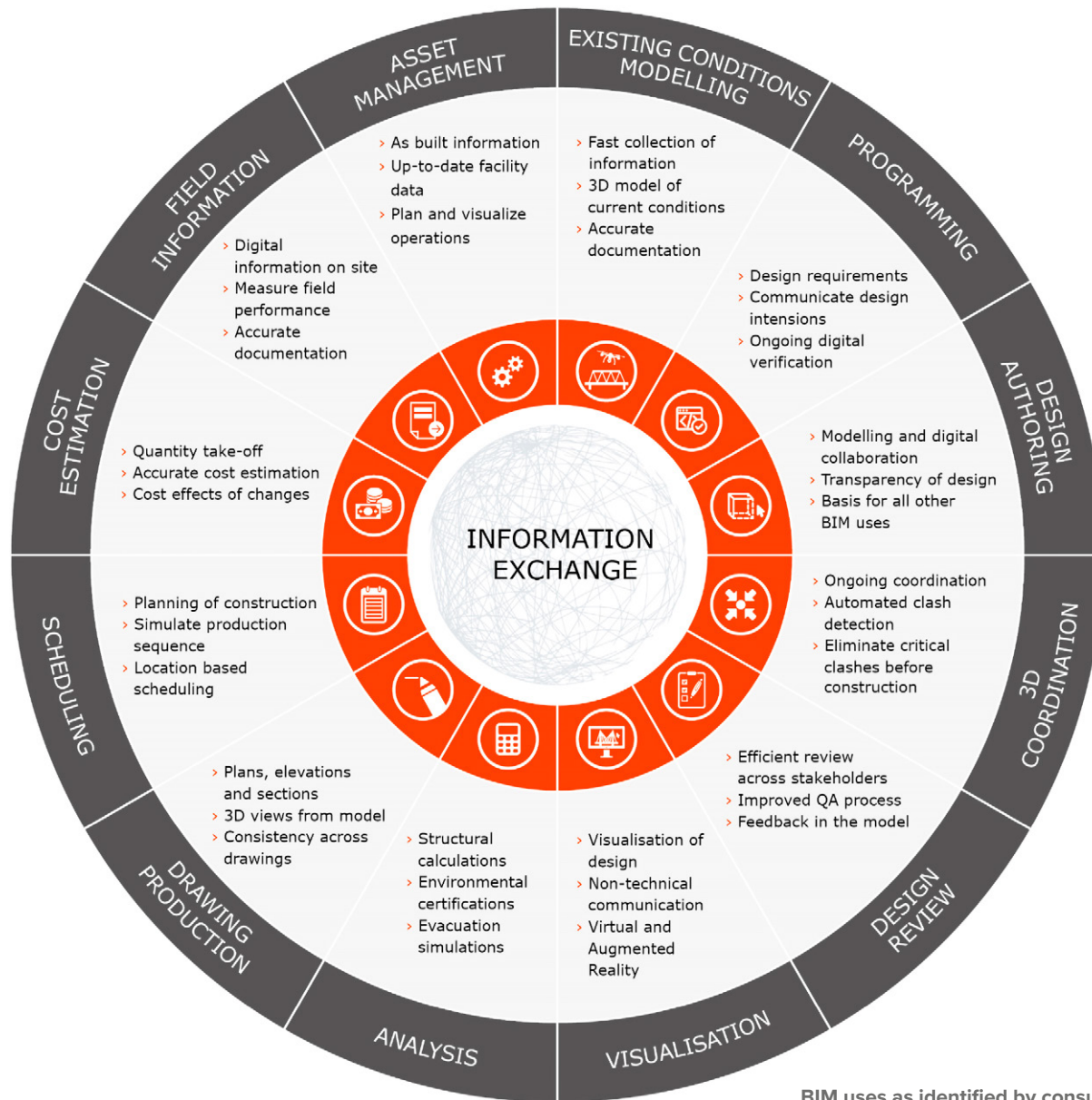

Figure 10. BIM uses as identified by consulting engineers (by courtesy of COWI)

5. Contracts

BIM does not substantially change the content of the Employer's and/or the Contractor's missions, but the way to respond to them. It obliges to be more explicit on roles, responsibilities and information traceability to increase its quality and therefore its value.

Few authorities (Dubai, UK, Finland, Hong Kong) have already included BIM in their legislation. Actual protocols such as CIC BIM, AIA Doc E202, Consensus Docs 301 are a good guidance for those who are drafting tenders/contracts. However, FIDIC and other institutions have not adopted any protocol yet. Secondly, International Finance Institutions (IFIs) have not included BIM in their bidding or tendering procedures.

The view of the EFCA BIM task force is that there is no special need to change the overall contracts. An annex to the contract or a protocol will allow the practitioners to answer two basic questions:

- Who does what, when and how?
- Who has access to what, when and how?

The following main points of such an annex in a FIDIC environment, for example, will have to define:

- BIM protocol: Who does what, when and how? Who has access to what, when and how?
- Legal definitions of terms
- Hierarchy provision in case of conflicts between the protocol and contractual provisions
- Duties, obligations and liabilities of the parties (Employer and Contractor)
- Duties, obligations and liabilities of the Engineer including responsibilities for deliverables and BIM management
- Programme and applicable standards

It appears that BIM will have an impact on legislation and contracts (definitions, responsibilities and obligations of the parties, priority of documents, confidentiality, and privacy). The three most important key issues are:

- intellectual ownership
- liability and
- insurances

5.1. Intellectual ownership

BIM is all about information management and communication. This process of sharing information is not only active during the design and construction phase of an asset but also after that, during facility management, operation or even repurposing. In order to take full advantage of the current and future developments like the 'internet of things', 'smart buildings', etc. it is important that the use of 3D models is at the disposal of the stakeholders and especially the owner of the asset. On the other hand, there are the intellectual property rights of the consulting or engineering company that are often translated to a very formal contractual agreement which does not allow easy access to the 3D models that are to be shared in a BIM process. Consensus could be found by slightly modifying these contractual agreements and allowing the owner of the asset to freely use and distribute the 3D models without formal approval procedures but with adjusted and 'contained' liability. It is therefore advisable to describe the conditions and limitations of the use of these 3D models. Some topics to address are, for example, the extent of shared graphical and non-graphical information that is allowed to be used during each project phase and the liability limits of the consulting or engineering company related to changes to the shared models done by the owner or third parties. Key in this issue is a solid communication, prior to commencement of the services, with all stakeholders about the minimal necessary information to be shared during each phase. Sharing only the necessary information will resolve related issues more quickly.

In addition to the above, another key problem regarding intellectual ownership should be addressed. The BIM model is evolving during the design and construction process from the preliminary 'volume model' into an 'as built model'. This means that all parties involved in this evolutionary process in the end share the intellectual ownership of the model, but each for their own contribution to the model. Intellectual property was also an issue before BIM but access to data was more difficult then, without the existence of a digital twin.

Through the management of metadata and CDE, ISO 19650 proposes the beginning of a solution which might be improved with the application of new technologies like 'blockchain' and 'smart contracts'. They could solve the problems of secure access to the digital twin and the take-off of information from it.

5.2. Software tools

However, BIM, along with huge data stores (Big Data) being accessible through the world wide web, changes the world for suppliers of ideas and services like architects and engineers. In the end, it could be possible that their ideas find their way easily into new projects – including all connected data like calculations, descriptions of materials and so forth. It is important to think about worldwide copyrights and Big Data based services that can protect intellectual property rights. The evolution of BIM has been strongly

supported by software and working in a BIM process is simply not possible without it in some way, whether it is limited to the creation of 3D models or whether it concerns the full cooperation of all stakeholders in a Common Data Environment (CDE).

Since BIM is all about evolving towards a digital twin, the ‘single source of truth’, software vendors become an important and powerful supplier in a project. Digitisation is more and more part of our global culture and is evolving and changing very fast. The lifespan of assets, however, is much longer than that of a certain software or versions of it and this fact alone can create issues of accessibility and ownership of data over time. It is advisable to thoroughly think through, and fix in contractual BIM agreements, the guaranteed access, readability, security, back-up, legally required physical copies of the project, access and property rights, etc. of all data being transferred during each phase and over the expected lifetime of an asset.

Specific attention should be drawn to cloud-based solutions with regard to ownership and the free use that software vendors have over the project data. In projects that make use of full CDE potential this could even concern all communication, financial and planning data. Also, contractual agreements should advisably contain mechanisms on how to deal with partners joining and leaving the project team with regard to software implications. For example, what if the company that established, and controls, the CDE platform leaves the project team?

In projects using multiple software with Cloud solutions, there is a risk that the concept of “Single source of information” may be compromised. The architecture, engineering and construction industry should apply open BIM standards and use open cloud software products. This is also in the interest of the IT-industry because their business case is growing, by a growing international standardised market, for the same tools.

5.3. Liability

Liability with regard to information exchanged should advisably be contained by clearly describing the value and limits of use for each type of delivery during each phase. This must ideally be done prior to contract and will concern mainly 3D model information. However, in high level BIM projects that for example use CDE platforms, it can also be necessary to extend these agreements towards stored communication and calculation notes.

The concept of workflow and metadata embedded in the CDE requires to develop tools to manage the ownership and the lifecycle of models and information in order to provide the ‘Proof of evidence’.

Regarding liability it should be borne in mind that the results of the work of architects and engineers will come closer to construction sites compared to the times before BIM. It might occur that the classical ‘liability gate’ between consultant and contractor will disappear in the times of BIM covering the entire lifecycle. It’s fair to say that liability of architects and engineers may increase with BIM.



When using robots on site, or 3D printers, architects and engineers will also become, to a certain extent, contractors with a substantially higher level of liability. This will make it more and more necessary to change from company-based insurance coverage to a project-based insurance coverage.

5.4. FIDIC impact

With a growing adoption of BIM in construction projects (infrastructure and buildings), the EFCA BIM Task Force takes the view that a BIM Protocol in a FIDIC Environment and clear procedures are needed. This will provide certainty and clarity for BIM practitioners.

It is worth noting that potential clashes between protocols and contract conditions, as listed below, should be avoided:

- definitions
- design submission procedures
- supply and priority of documents
- documents to be supplied at the beginning and at the end of the construction phase
- hierarchy provision to deal with conflicts between the protocol and contractual provisions
- legal responsibilities and responsibilities of new roles (e.g. clash checker)

Appendices

Appendix 1: National video references and links

Several videos are available to help understand BIM and its benefits:

(a) What is BIM?

- ‘OpenBIM: the Sky is the Limit’
Initiative from Uneto-Vni, Rijkswaterstaat and Building Information Council, The Netherlands
<https://www.youtube.com/watch?v=FPaja7mLiTE&feature=youtu.be>
- ‘What is BIM?’
National Building Specification National BIM Library
https://www.youtube.com/watch?v=_beeFtrgQJE

(b) Asset information management using BIM with open standards and a digital twin

- ‘Information Management for European Road Infrastructure using Linked Data for the Lifecycle of Roads’
Conference of European Directors of Roads
<https://www.youtube.com/watch?v=aKlc4Cj9lmw&feature=youtu.be>

(c) OpenBIM and buildingSMART

- ‘What openBIM Does for You - buildingSMART in Four Minutes’
buildingSMART, Norway
https://www.youtube.com/watch?v=2m_IL99WOzQ

(d) Systems engineering and BIM

- ‘SE-Boost - Systems Engineering – ENG’
Building Information Council, The Netherlands
<https://youtu.be/wmaUfpOfX7s>

Appendix 2: Exchange and sharing (container-) information

Assets should be described by open standardised object types from open standardised ‘object type libraries’ (OTLs). An OTL enables the use of a standardised language and standardised object-type-specific specifications for their assets.

Container-based collaborative working basically means two things:

The principle that the author or originator of a piece of information, for example a model or a drawing, is responsible and liable for the content and quality still applies.

Certain rules concerning the processes of information management are defined so that data and information can be exchanged in a secure and efficient way.

An example of a container is the ‘COINS’¹³ open standard: ‘constructive objects and the integration of processes and systems’ which builds on geometry standards (IFC, DWG), GIS standards (GML, CityGML) and process standards (IDM Part 2) as in the figure below.

COINS supports systems engineering (SE), OTL and the combination of different data structures. Information, which consists of combinations of different data structures, to be exchanged via a COINS container.

Information can also be shared on-line by existing linked data/semantic web technology instead of being exchanged via a container. This prevents issues with the regulatory, procurement and legal aspects of the information to which it is linked because it is used on-line and the information stays with its owner.

An example of asset information sharing is the European road object type library (EUROTL) developed by INTERLINK for the Conference of European Directors of Roads (CEDR). (website: www.roadotl.eu).

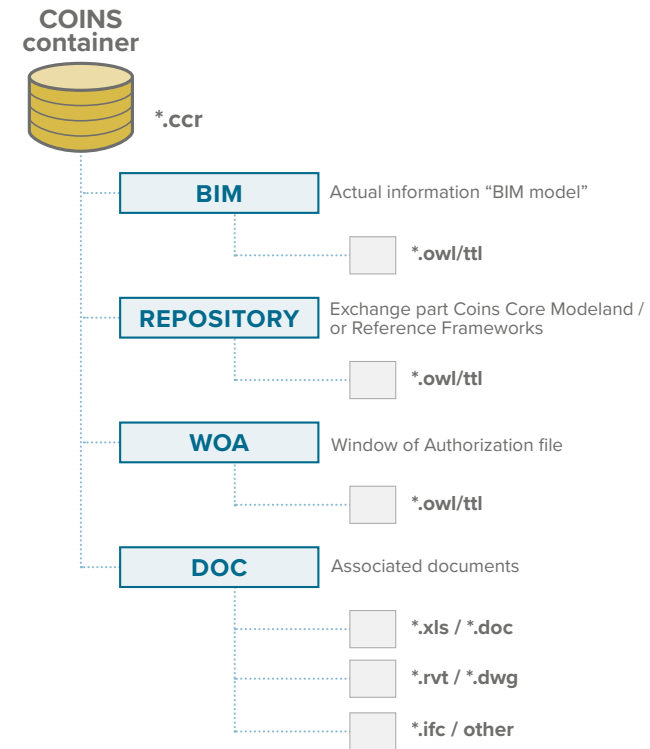

Example of an information exchange via a candidate open standardised COINS container

¹³ Constructive objects and the integration of processes and systems http://www.coinsweb.nl/index_uk.html

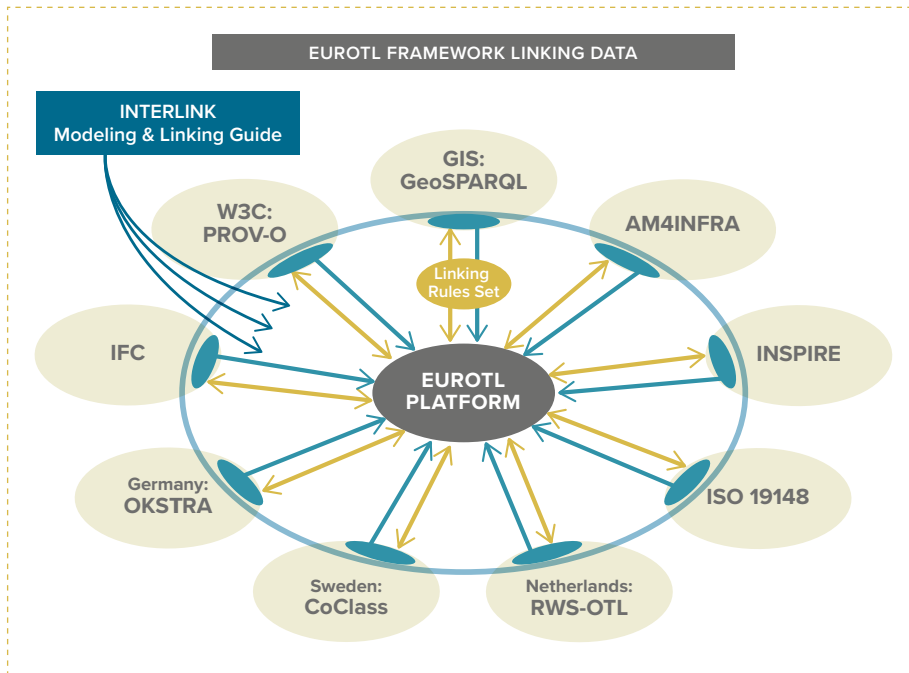

An example of data linked online via an open standardised object type library¹⁴

The European Road OTL framework uses the powerful linked data/semantic web technology, which draws on the online standardised open data available about roads, traffic and their environment at a European level. By using existing international open standards for the asset data, it is possible to link different existing asset information systems. Each link is provided by its own IT supplier. It helps stakeholders to enhance interoperability and to make informed strategic, tactical and operational decisions about lifecycle road asset management.

¹⁴ Böhms, M. (ed) (2017). Principles for a European Road OTL. Netherlands: INTERLINK project. Accessed: <http://www.cedr.eu/strategic-plan-tasks/research/cedr-call-2015/call-2015-asset-information-using-bim/>

Appendix 3: References to BIM guidance in Europe



Appendix 4: Table of project and task information management functions

Project information management	Task information management	Interface management	Information author	Information coordination	Information facilitation
AUTHORITIES					
<ul style="list-style-type: none"> Accept/reject information at each information exchange within the common data environment 	<ul style="list-style-type: none"> Confirm that information is suitable for issue within the common data environment 	<ul style="list-style-type: none"> Propose resolutions to clashes 	<ul style="list-style-type: none"> Ownership of model information 	<ul style="list-style-type: none"> Make sure that coordination issues in the information model are detected 	<ul style="list-style-type: none"> Interact with appointing party, user coordinator, project manager to make sure information and communication processes are effective
TASKS					
<ul style="list-style-type: none"> Define project information requirements Enable reliable information exchange through the information environment, and information management tools Maintain and receive information into the information model Enable integration and coordination of information within information model Configure information in line with project requirements Populate the Information exchange format for the information model 	<ul style="list-style-type: none"> Direct the production of task information in compliance with standards, methods and procedures Direct the production of task information using agreed systems 	<ul style="list-style-type: none"> Manage spatial coordination on behalf of a task team in line with the federation strategy Propose resolutions to coordination clashes 	<ul style="list-style-type: none"> Develop constituent parts of the information model in connection with specific tasks Produce information deliverables 	<ul style="list-style-type: none"> Coordinate information Configure information Enable information exchange in different format 	<ul style="list-style-type: none"> Cultivate active partnerships between Information authors Facilitate meetings and processes

European Federation of Engineering Consultancy Associations

Ave des Arts 3/4/5
B - 1210 Brussels
Phone: +32 (0)2 209 07 70
Fax: +32 (0)2 209 07 71
efca@efca.be
www.efcanet.org

ISBN 9789075085075



APPC

ASSOCIAÇÃO PORTUGUESA DE
PROJECTISTAS E CONSULTORES
PORTUGUESE ASSOCIATION OF
ENGINEERING AND MANAGEMENT
CONSULTANTS



Representing
FIDIC in Europe